

ISTRUZIONI PER IL MONTAGGIO

F - 50 x 50 x 100 cm.

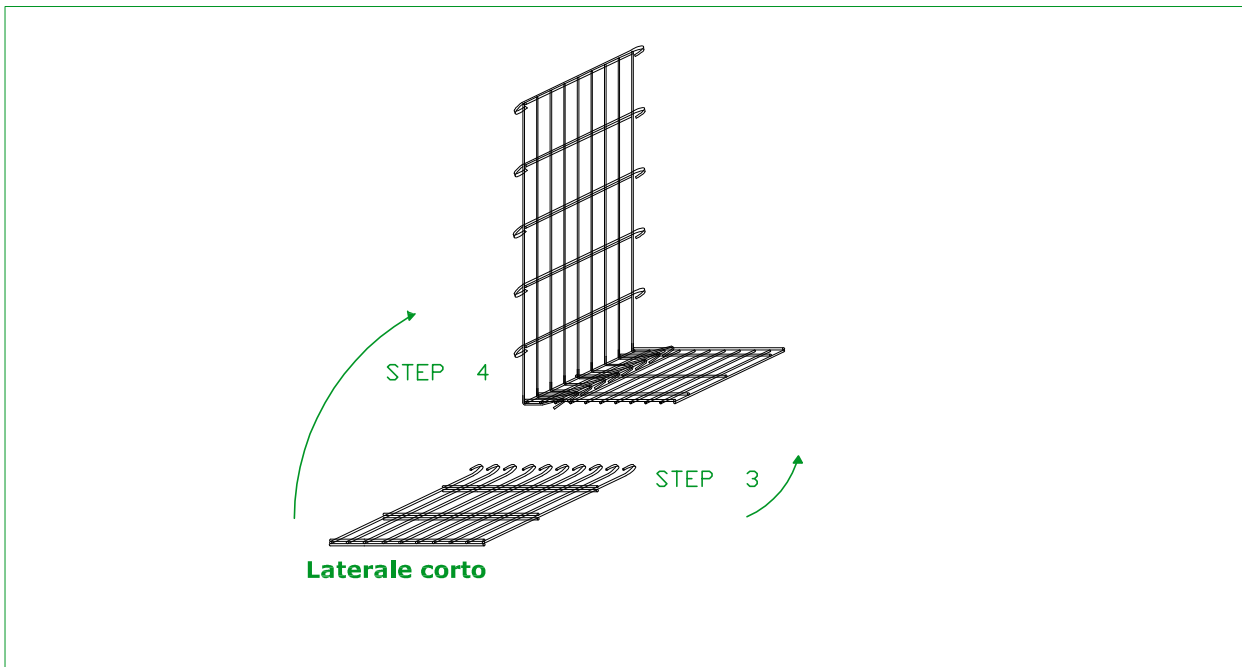
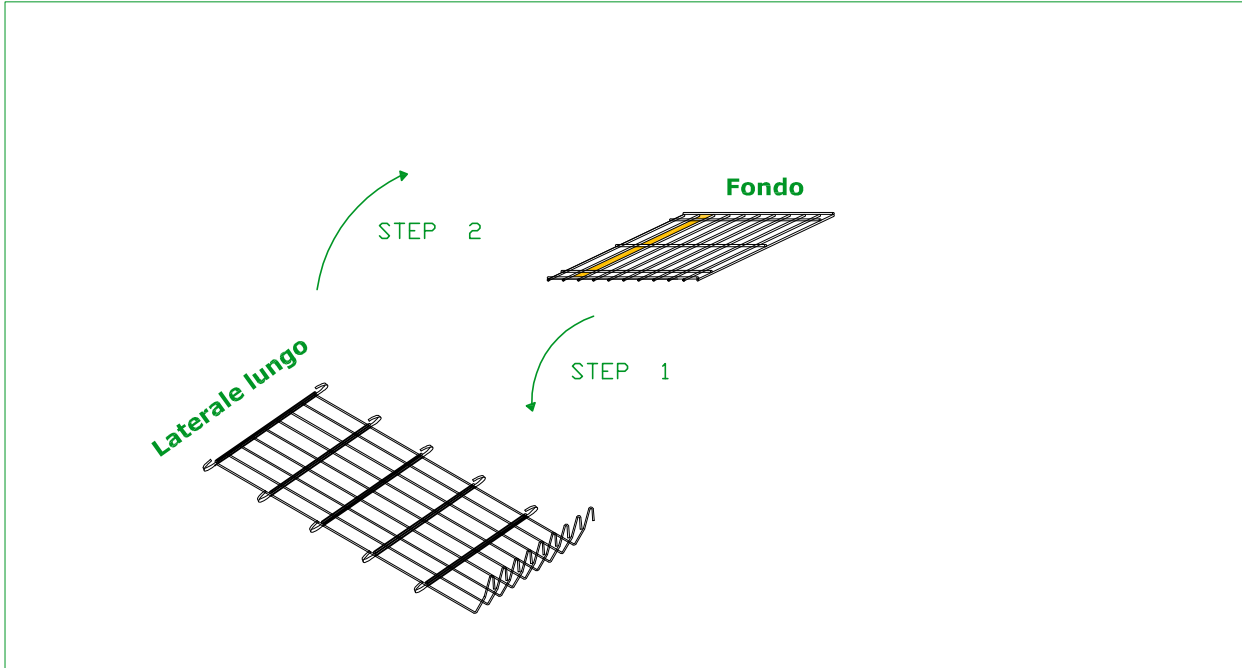

GIARDEN LINE

**FIORIERE - HOCHBEET - JARDINIÈRES -
PLANCERS - JARDINERAS**

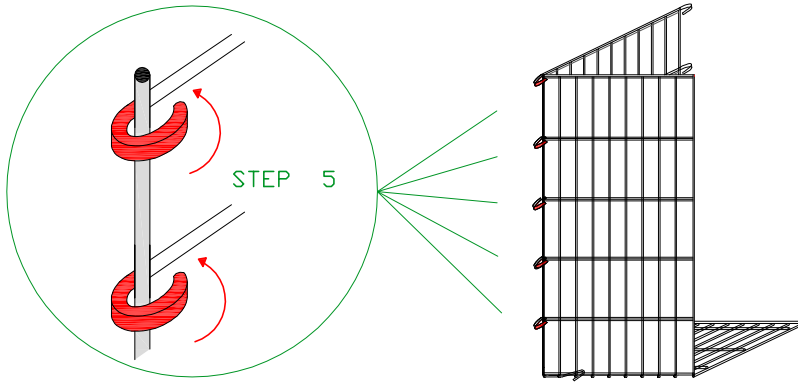

STEP 5

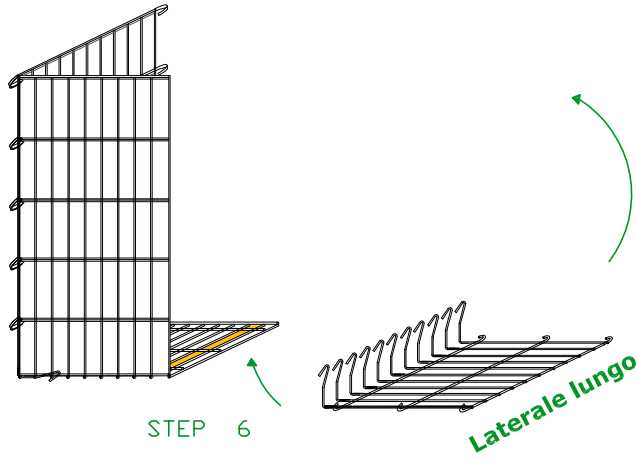

STEP 6

STEP 7

Laterale lungo

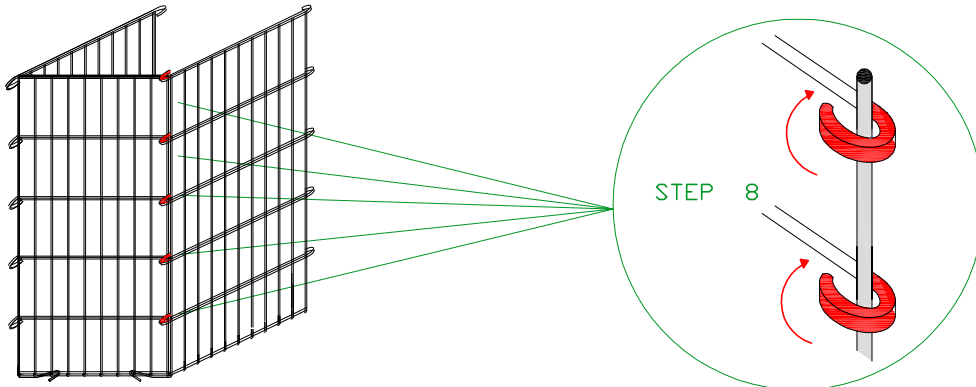

STEP 8

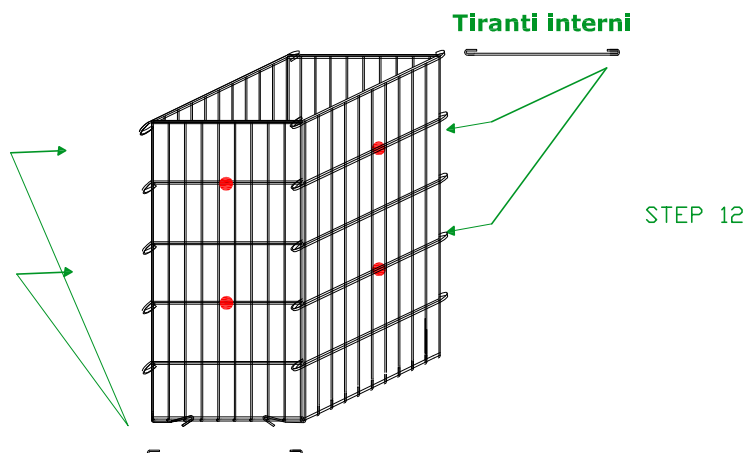
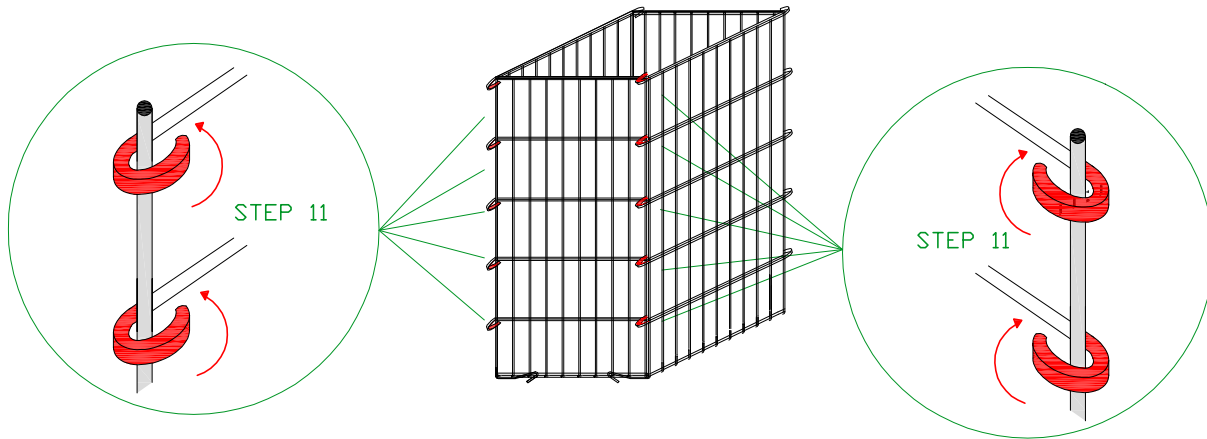
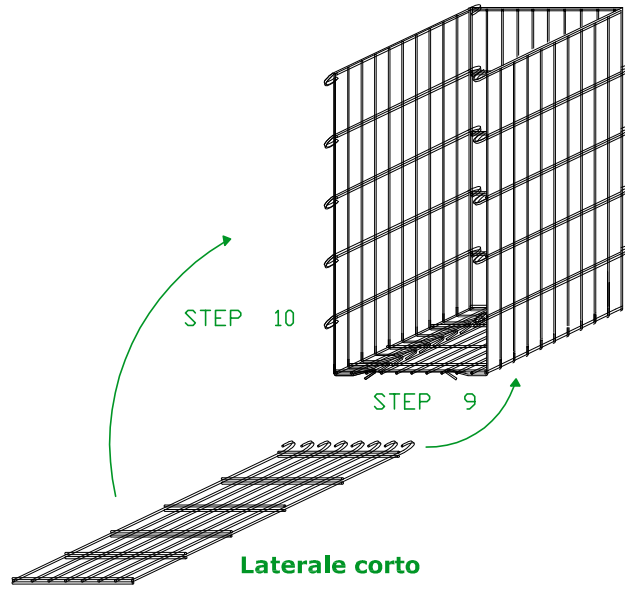

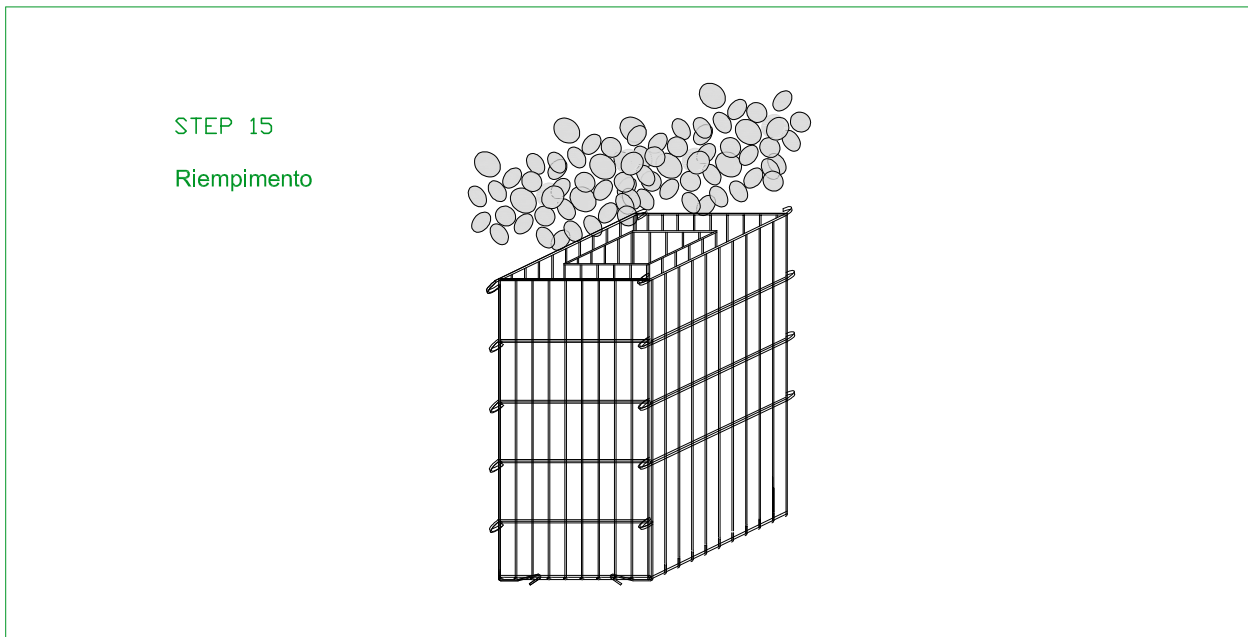
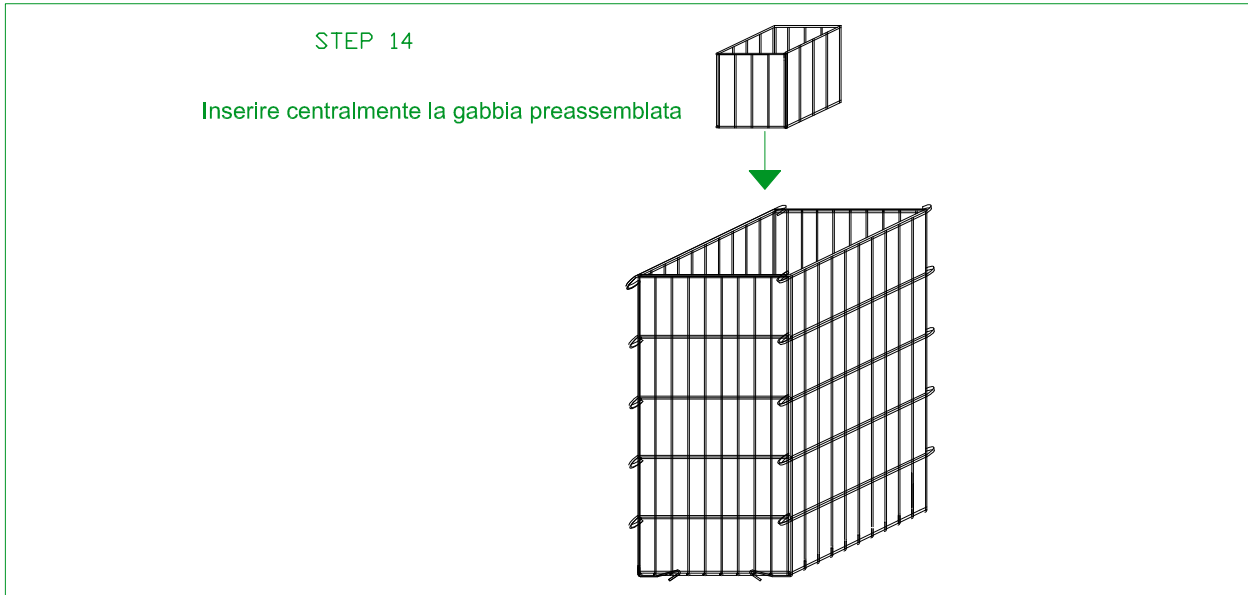
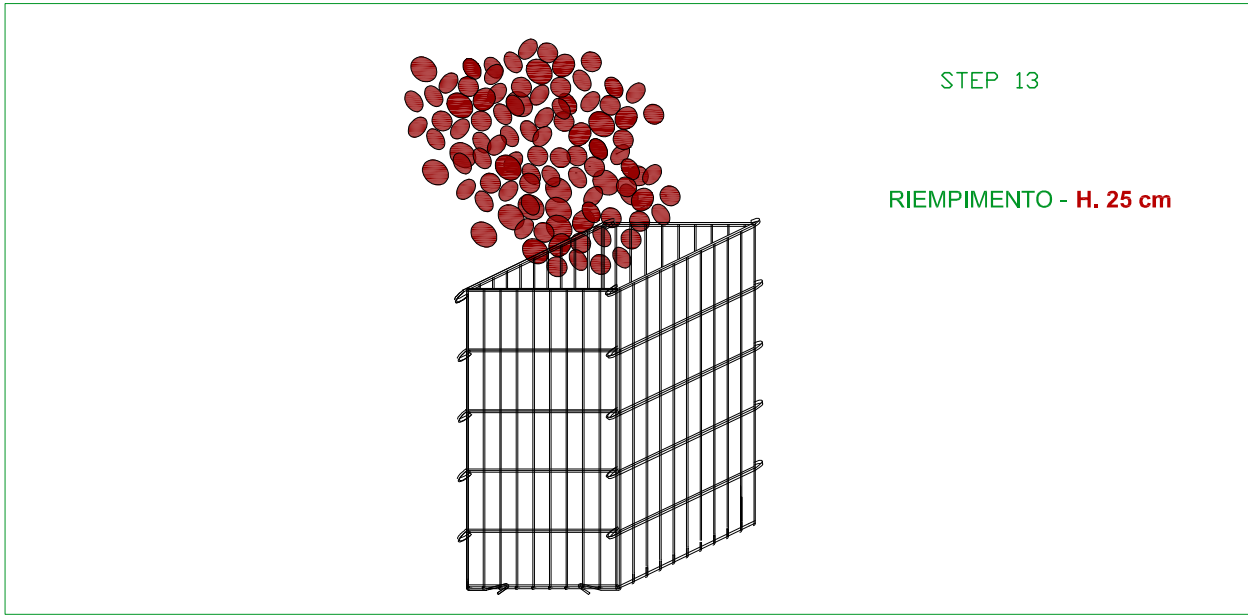

STEP 16
Inserire il geotessile

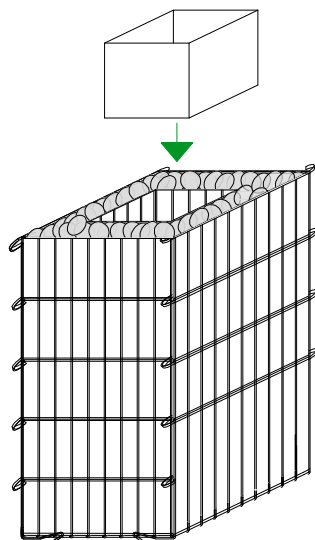

STEP 17
Coperchio

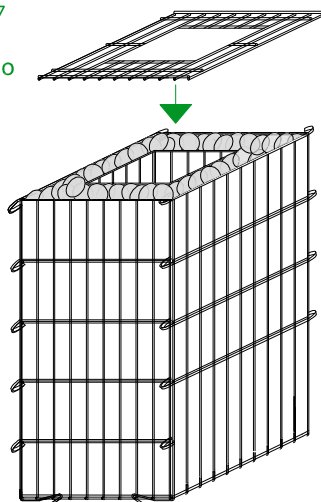



STEP 18

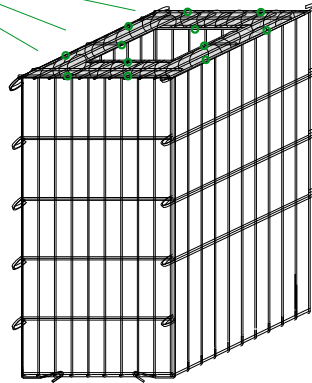

STEP 19
Riempire con terriccio

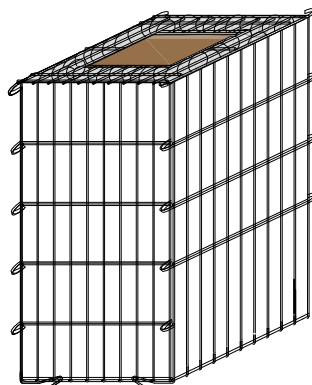

° Gabbia pronta per il trasporto sul cantiere -
movimentazione tramite pettini LSB



max 2000 Kg.